

aerflo™

a e r 1

User Manual



WARNING! Using this product with liquids above 120°F/50°C may result in injury.



WARNING! Do not freeze this product or use below 33°F/1°C



WARNING! This product is not dishwasher safe.

Copyright

©2024 Spritz, inc. All rights reserved.

No part of this document may be reproduced or transmitted in any form or by any means, or translated into another language without the prior express written consent of Spritz, inc.

Trademarks

Aerflo™ and Aerflo Mark are registered marks in the United States and other countries.

Patents

Please visit aerflo.co/patents

Compliance

All Aerflo products are BPA/Phthalate Free and compliant with California Proposition 65.

Aerflo Carbon Capsules are designed to DOT 3AL specifications.

User Manual

For Aerflo™ Aer₁ System

Table of Contents

In the Box.....	1
How to Spritz in 6 Steps.....	7
Efficiency Guide & Other Device Uses.....	15
How to Clean & Disposal.....	19
Carbon Capsule Swapping & Refilling...23	
Safety Guide.....	29
FAQs.....	33
Warranty, Guarantee, Liability.....	37
User License, Terms & Conditions.....	41

In the Box

In the box

One (1) Aer₁ Device

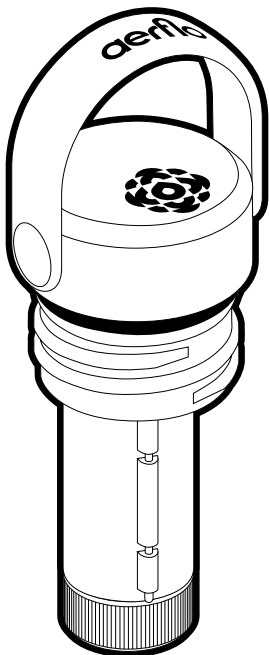

In the box

Six (6) carbon capsules

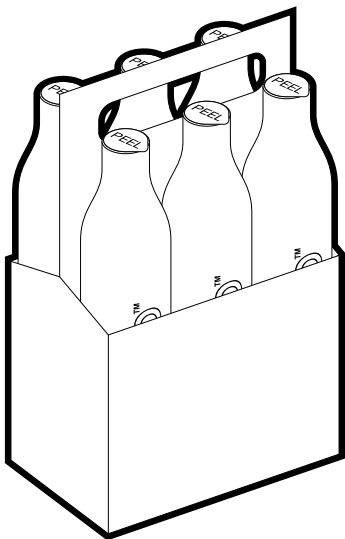

In the box*

3 • 6 Capsule holder

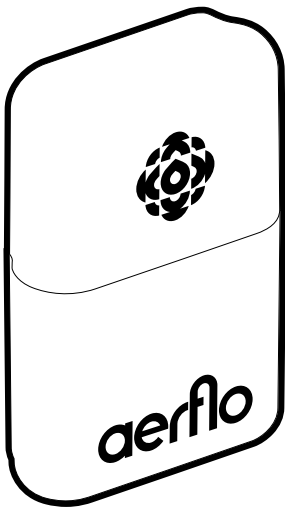

*Depending on the kit purchased, your delivery box may contain one or more of these items.

In the box*

1x Refill Pack

If your kit did not contain a refill pack, visit aerflo.co/getgas to get started with your first refill.



*Depending on the kit purchased, your delivery box may not contain these items.

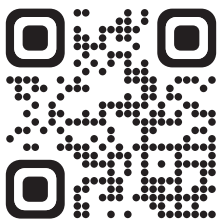

aerflo.co/start

Become a pro in 1 minute

Scan this QR code for a video guide

How to Spritz

In 6 steps

How to Spritz

1. Add Water

Add water to the fill line. Overfilling the bottle will result in spraying water.

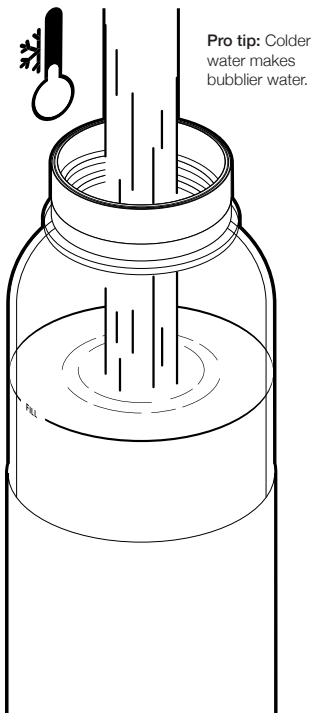

How to Spritz

2. Insert a capsule

a. Remove the sticker from the capsule.

b. Place the capsule into the end cap. Thread it into the Aer1 device extra tight.



Pro tip: If capsules are warm, cool them before using. Capsules may be refrigerated.

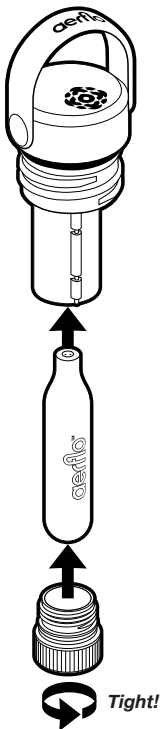

How to Spritz

3. Screw the device on

Screw the device on. Ensure it is threaded tightly and you can no longer see the gray o-ring.

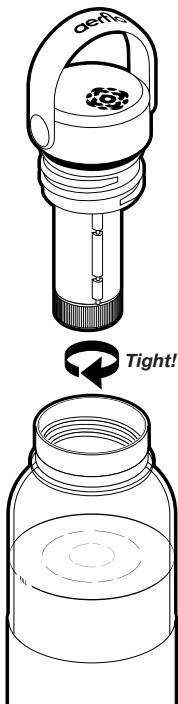

How to Spritz

4. Tap the button

Tap the button until you hear the device vent pressure. This is the relief valve opening. At times mist will accompany pressurized air.

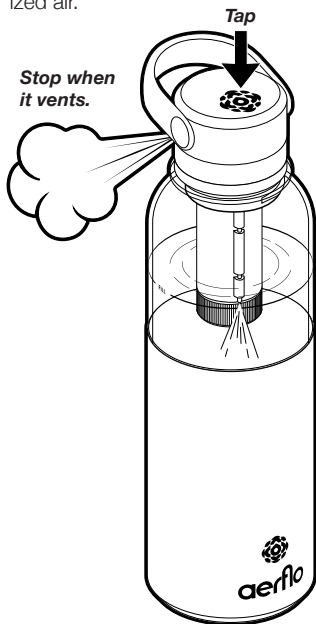

How to Spritz

5. Shake your bottle

Shake your bottle for about three seconds.

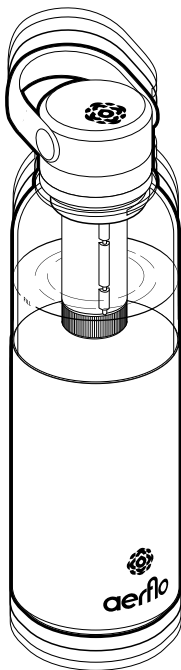

Pro tip: More shaking equals more bubbles

How to Spritz

6. Repeat steps 4 & 5

Spritz

(Tap and shake)

two more times

to reach your desired carbonation level. Each time you tap and shake, the beverage will become more carbonated.



**Then open
and enjoy!**

Spritzing Table

Finding your preference

Customizing your carbonation and matching your preferences is simple. Simply adjust the number of spritzes:



1 spritz



2 spritz



3 spritz



4 spritz

Efficiency Guide & Other Device Uses

Efficiency Guide

Want better results?

Each capsule should make 4 bottles (2L) of sparkling water when used according to this guide.



Always use **cold water** (45° or below). The colder the better.



Always add **water** exactly to the **fill line**.



Always **tap the button** instead of pressing and holding.



Shake vigorously after spritzing to better mix the water & CO₂.

Visit aerflo.co/efficiency for more information.

Other Uses

Preserve your water

If you want to drink half a bottle and save the rest for later:

- 1.** Screw the Aer1 device onto your bottle containing previously carbonated water.
- 2.** Tap the button two times.

This will re-pressurize your bottle, keeping the sparkling water fresh for later.

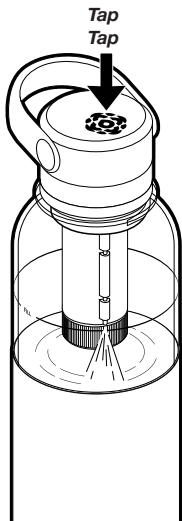

Other Uses

Re-carbonating water

If your water has gone fully or partially flat:

Simply fill the bottle back to the fill line and carbonate according to the guide starting on page 6.

If your water still has carbonation left, it will take less gas (and therefore fewer button taps) to achieve your desired result.

How to Clean

(we recommend once per month)

Disposal

How to Clean



WARNING! This product is not dishwasher safe.

Disassemble device

Remove end cap; if you have a capsule in your device, remove it and set it aside.

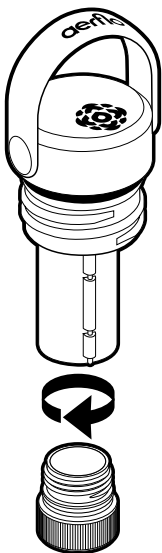

How to Clean



WARNING! Do not wash this product with water over 120°F / 50°C.

Hand wash device

Wash device with mild soap and water. Rinse and allow to fully dry before use.

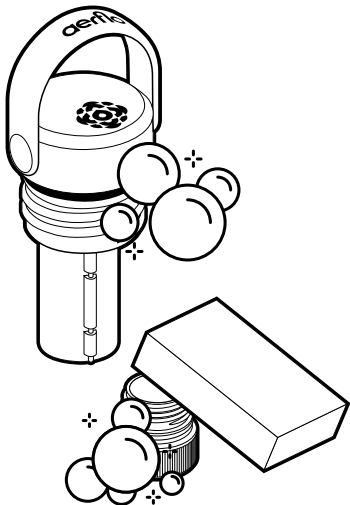

Materials & Disposal

Aerflo Carbon Capsules are the property of Spritz, Inc. and should always be returned to Aerflo rather than disposed of. Please contact us at hello@aerflo.co with any questions.

The Aerflo Aer1 System is constructed entirely from BPA Free, recyclable materials including:

Bottle

300 Series Stainless Steel

Eastman Tritan™

Silicone

Plastics: ABS, TPE

Device

300 Series Stainless Steel

Lead Free Brass

Eastman Tritan™

Plastics: Delrin, Nylon, PETG

Rubbers: TPU, NBR, FKM, EPDM, Silicone

Carbon Capsules

Food Safe Anodized T6 Aluminum

300 Series Stainless Steel

Lead Free Brass

Oxygen Free Copper

Rubbers: NBR, EPDM

Capsule 3•6 pack

Silicone

PETG Plastic

Contact your local authority for information on recycling in your area.

Carbon Capsules

Swapping & Refilling

Carbon Capsules

How to swap

Unscrew end cap & remove empty capsule.



Swap with a fresh one from capsule holder.

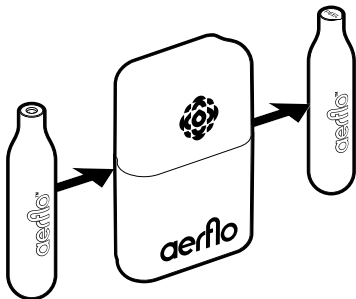

Remove the sticker and place into the end cap. Screw the end cap on to the device tightly.

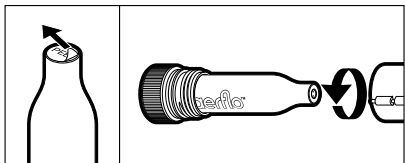

Carbon Capsules

Managing your capsules

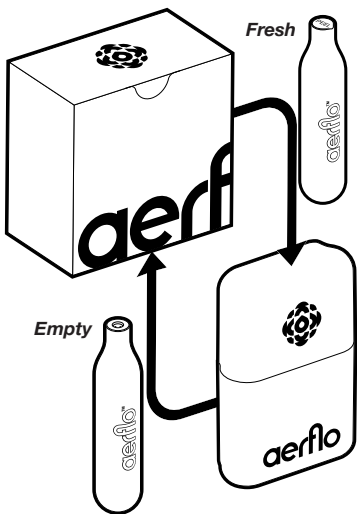

Every Aerflo System comes with extra capsules, so you will never be without. Transfer new capsules from your refill pack to your capsule holder. Exchange empty capsules with full ones from your refill pack. When your refill pack contains only empties, it's time to return.

Carbon Capsules

How & when to refill

1. Swap empties for full capsules from your refill pack. When it's full, it's ready to return.

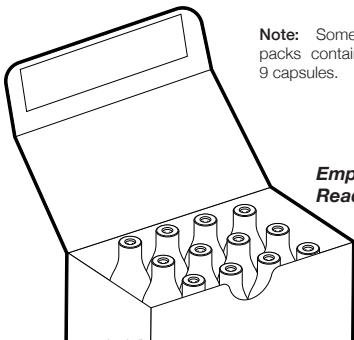

Note: Some refill packs contain only 9 capsules.

*Empties
Ready*

2. To prepare for shipping, peel the backing from the flap and firmly press the lid closed.

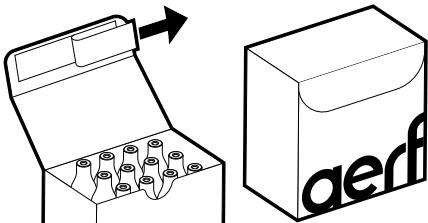

Carbon Capsules

How & when to refill

- Drop the box at any USPS pickup location. (e.g. mailbox, office, doorman, post office)



- When USPS scans the label, a new pack is shipped to you along with a confirmation email. Shipping time is usually 5-7 days.

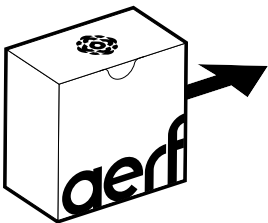

Carbon Capsules

How we refill

After receiving your refill pack with empties, our automated facility counts, cleans, inspects, refills, and inspects again to prepare capsules for the next customer. Due to this, capsules in a refill pack will not always look brand new, but are always clean and cleared for use.

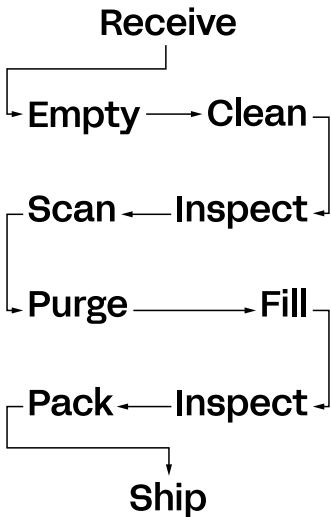

Safety Guide

Safety Guide

Do

Only use with Aerflo bottle or compatible bottles listed at aerflo.co/compatible.

Use only plain water.

Add any flavor only *after* spritzing plain water.

The Aer1 is hand-wash only. Keep the device and the Carbon Capsules in a cool, dry place. Always remove the sticker from a capsule prior to use.

If the Carbon Capsules are warm to the touch, cool the Carbon Capsules by running cold water over them or placing in the fridge.

Cool the device and Carbon Capsules immediately if any component is hot.

If the top rubber component fills with air or domes up in any way, stop using the product immediately and contact us at hello@aerflo.co.

Safety Guide

Do not



WARNING! The T.S.A. does not allow carbon capsules in any baggage on an airplane.

Do not use Aer1 System with liquids above 120°F/50°C. Exposure to heat may cause damage to the device or injury to yourself.

Do not place any component of the Aer1 System in a dishwasher. Hand wash only. (See page 20)

Do not tamper with, refill or expose Carbon Capsules to heat, open flames, or direct sunlight for extended periods.

Do not use the Aer1 device or Carbon Capsules if warm to the touch. Cool before use.

Do not use a bottle that is badly dented or damaged.

Do not use with liquids other than water.

Do not use if the Aer1 device or Carbon Capsules are visibly cracked or damaged.

Do not place either Aer1 device or Carbon Capsules in the microwave or freezer.

Do not expose the aer1 system to sunscreen.

Safety Guide



WARNING! If cap balloons during use, stop use and relieve all pressure immediately.

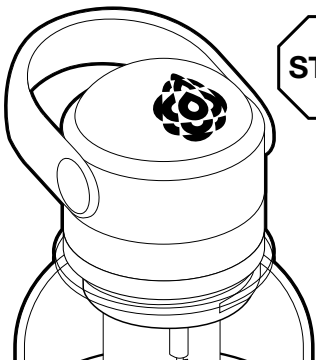

Remove the capsule and confirm the sticker has been removed.

Confirm the bottom cap is screwed tightly.

Cool all components.

If none of the steps above solves the issue, the device is broken. Please contact hello@aerflo.co to exchange your cap.

FAQs

FAQs

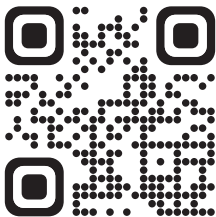

aerflo.co/FAQ

Scan the QR above to view our more extensive digital help center.

Q: How many bottles does each capsule make?

A: Each capsule makes four bottles when used according to the guide.

Q: Why do I need to shake my bottle after tapping the button?

A: Shaking your bottle helps the water and CO₂ mix. This is a necessary step to get the most out of your system.

Q: I pressed the button and I did not hear a valve sound. What happened?

A: As you empty a capsule there is less pressure in the system and sometimes not enough to trigger the relief system. Press the button until the capsule is empty and swap in a new capsule

FAQs

if needed.

Q: Is it ok if there is mist coming out of the cap when I am carbonating water?

A: Due to the mixing process, slight mist is unavoidable. If you're experiencing a lot of water, this is a side effect of overfilling your bottle. Adjust your water level to the fill line and try again. Additionally it can be a side effect of capsules being too warm. Try cooling them before use, or storing them in the fridge.

Q: If I want to add flavor, how do I do that?

A: Add flavor (power packets, flavor syrup, fresh fruit) only **after** you have carbonated plain water.

Q: Can I carbonate less than a full bottle of water?

A: Technically you can, but it is a huge waste of CO₂ as it is very inefficient.

Q: How much pressure does this device generate in my bottle?

A: 45 PSI when used as guided.

Q: The Aer1 is a little bit difficult for me to press

A: If you find pushing the button difficult, hold your bottle at the bottom or place it on a flat surface. Use your thumb or your first two fingers to press down on the button. If that does not work, try cooling the capsules under cool water or in the refrigerator

FAQs

Q: Can I spritz with ice in the bottle?

A: Yes, we recommend letting the ice cool your water first.

Q: Why do I need to shake each bottle after spritzing?

A: Shaking helps the water and CO2 mix. This is a necessary step to get the best efficiency per capsule.

Q: I tapped the button on my Aer1, but my bottle is empty. Is it safe to open?

A: Yes! This is completely safe and there is no need for concern. You'll just hear a release of the CO2 that was built up in the bottle.

Q: I think something is wrong with my Aer1, what should I do?

A: Please reach out to the customer experience team at hello@aerflo.co and they will help you troubleshoot any issues you might have.

Warranty
Guarantee
Liability

Limited 1-Year Warranty

Your Aerflo™ Aer1 System (“Product”) includes a one (1) year limited warranty from the date of purchase (“Warranty Period”) against defects in materials and workmanship. This is the only express warranty for this product and is in lieu of any other warranty or condition.

Aerflo will repair or replace your product free of charge on the following conditions:

1. Products returned under this warranty must be accompanied by a description of the defect together with a copy of your proof of purchase and your full contact information and delivery details: name, telephone, complete address.
2. Products returned to aerflo must be adequately packaged. aerflo will accept no liability for goods lost or damaged in transit from the customer.
3. Products must have been used strictly in accordance with instructions supplied. aerflo will have no liability for defects caused by accident, misuse, alteration, or neglect.
4. aerflo accepts no liability for any consequential loss, damage, or expense of any kind resulting from the machines or accessories of the use thereof.
5. This product is designed for use only with aerflo branded carbon capsules. This warranty does not cover any malfunction or damage caused by the use of third party co2 products.

Please visit aerflo.co/warranty for a full copy of the Aerflo Aer1 System Warranty.

Warranty Terms

The Warranty does not apply to:

1. cosmetic damage, including but not limited to scratches and dents;
2. damage caused by external cause, including but not limited to accident, abuse, misuse, hot water or heat;
3. damage caused by operating or use of the Product other than in accordance with applicable guidelines from Aerflo, including the Product's user manuals, technical specifications, etc.;
4. a Product that has been modified; or
5. defects caused by normal use or otherwise due to the normal aging. This warranty is not transferable.

Money-Back Guarantee

We accept returns of Aerflo Aer1 Systems as long as they are in new, unused condition and in their original packaging and purchased from us. Returns are accepted for up to 30 days from date of purchase.

Liability

Aerflo does not bear any responsibilities when personal injury or property loss is caused due to the following reasons:

1. Damage to the product due to improper use or misuse of the product.
2. Alteration, change, tampering with, maintenance of the product by anyone other than the manufacturer.
3. Using the product with non-approved gas cartridges.
4. If the damage is caused by natural calamities, improper environmental use of force majeure.

User License Terms & Conditions

User License

THE CAPSULES: (i) ARE OWNED BY AERFLO; (ii) ARE PROVIDED UNDER THE LICENSE GRANTED HEREIN; (iii) ARE LICENSED SUBJECT TO THE COMPLETE TERMS OF USE, WHICH THIS USER LICENSE AGREEMENT IS A PART OF; (iv) ARE PATENT PENDING; AND (v) ARE NOT FOR SALE. ALL CAPSULES CAN ONLY BE RETURNED TO AERFLO.

This User License Agreement is a legally binding agreement between you, Spritz, Inc., D/B/A Aerflo and its licensees (collectively, "**Aerflo**," "**we**," "**us**," or "**our**"), and is a part of the Terms of Use located at aerflo.co/termsofuse (collectively, the "**Agreement**"). The Agreement governs your use of Aerflo's CO2 capsules (the "**Capsules**"). **Our Capsules are only licensed to you and remain the property of Aerflo.** By using the Capsules, you agree to the entire Agreement, including the Terms of Use.

1. Our Capsules are protected by trademark, patent and other proprietary rights and laws. Aerflo retains ownership of our Capsules. Subject to your compliance with this Agreement, we grant you a limited license to use our Capsules for personal, non-commercial purposes. Your additional rights and obligations are explained further in the Terms of Use.
2. To ensure your safety and protect our rights, we are solely responsible for refilling our Capsules. Our Capsules may only be refilled by us; any refill by you or by a third party violates the Agreement.
3. When ready to refill our Capsules: (1) place our empty Capsules back in their Refill Pack packaging after use; (2) use the pre-printed and pre-affixed return label on the Refill Pack and drop them off in the mail; and (3) your next Refill Pack of Cap-

Terms & Conditions

sules will be charged to your payment method on file and shipped to you. Any Capsules returned to Aerflo must be in their original condition and free from any damage or tampering. Capsules or Refill Packs that have been damaged, tampered with, or sent back incomplete will not be accepted and may result in additional charges. Any refunds or exchanges are subject to our return policy located in our Terms of Use.

4. You may not use our Capsules for any fraudulent or unlawful purpose, and you may not take any action to interfere with a user's safety and health.

Your use of our Capsules is subject to the Terms of Use located at aerflo.co/termsfuse, which can be accessed via scanning this QR code:

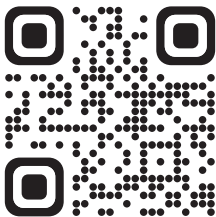

For questions or customer support, please contact us at hello@aerflo.co

Any dispute, controversy or claim arising out of or relating to a Capsule or to this Agreement, including, but not limited to, claims of personal injury and/or property damage, shall be submitted to arbitration in accordance with the Terms of Use available at:

aerflo.co/termsfuse

Thank you for being a part of Aerflo.

If you have any questions,
please contact us at
hello@aerflo.co

